

Origami cubes for LED string lights

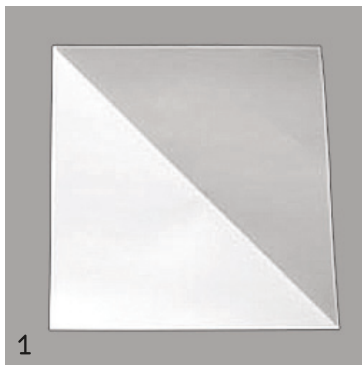

1

Start with pattern side down. Fold diagonally.

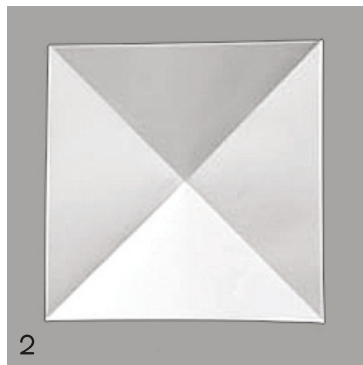

2

And fold diagonally again.

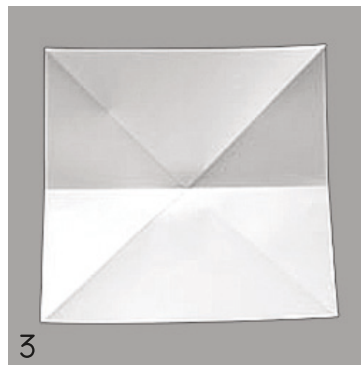

3

Turn the paper over and fold lengthwise.

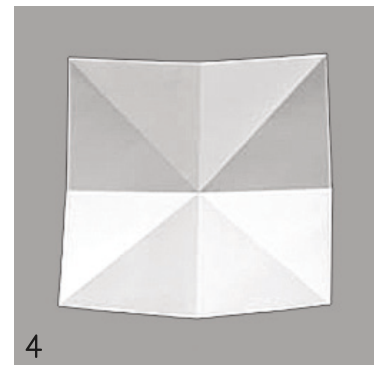

4

And fold lengthwise again.

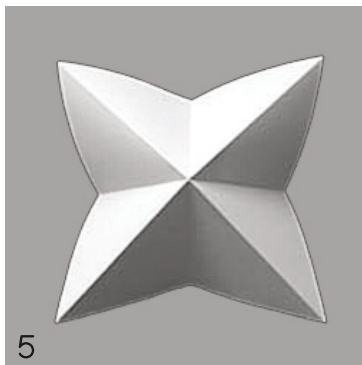

5

Lift up the centerpoint like this (pattern should be out now),

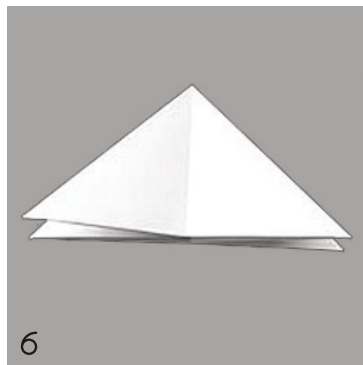

6

and flatten like that.

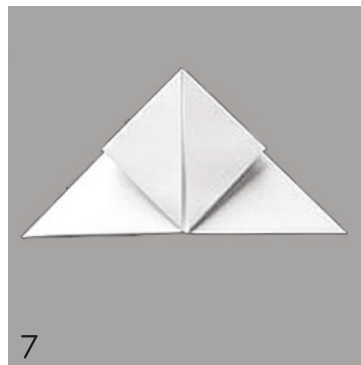

7

Fold tips upwards towards top,



8

turn over and repeat.



9

Fold in these tips towards the centerline,



10

turn over and repeat.



11

Fold underlying tips outwards, along the upper layer folds.



12

Fold these inwards again, into a neat double 'flap'. Repeat x 4.



13

Tug these 'flaps' into the upper layer's matching 'pockets'. Easier with a bit of help from a tool -



14

use a knitting pin or similar! Turn over and repeat this on both sides.

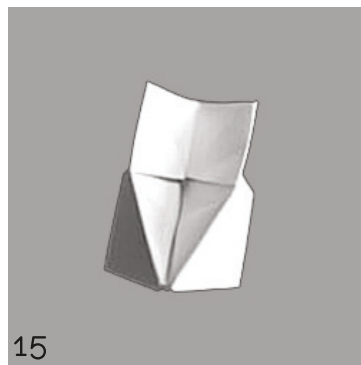

15

Lift up the folded sides gently, and blow into the little hole that naturally appears at the bottom,

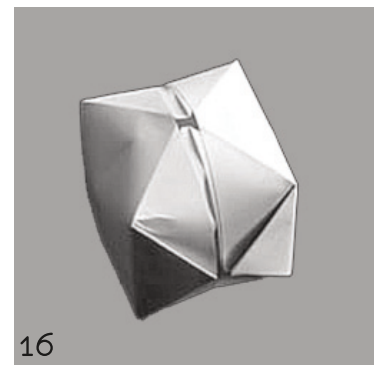

16

and gently tug and press and fold your little cube into shape. The hole fits the LED light perfectly.

A great tip is to twist one of those tiny rubber bands ('loom bands') around each LED light, just below the bulb. That will keep the paper cubes from sliding off the string lights. **REMEMBER: this is *only* safe, and not a fire hazard, with the modern type LED string lights.**